

## PQxxxY3H3ZxH Series PQxxxY053ZxH Series

Surface Mount, Large Output Current Type  
Low Power-Loss Voltage Regulators

### Features

1. Low power-loss (Dropout voltage: MAX. 0.5V)
2. Compact surface mount type package  
(Size: 10.6×13.7×3.5mm)
3. High output current type
4. Low voltage operation (Minimum supply voltage: 2.35V)
5. High-precision output type  
(Output voltage precision: ± 1%)
6. Overcurrent, overheat protection functions
7. RoHS directive compliant

### Applications

1. PC motherboard, PC peripherals
2. Power supplies for various electronic equipment such as AV, OA

### Model Line-up

Output current (Io)	Package type	Output voltage (Vo)		
		1.5V	2.5V	3.3V
3.5A	Taping	PQ015Y3H3ZPH	PQ025Y3H3ZPH	PQ033Y3H3ZPH
	Sleeve	PQ015Y3H3ZZH	PQ025Y3H3ZZH	PQ033Y3H3ZZH
5A	Taping	PQ015Y053ZPH	PQ025Y053ZPH	PQ033Y053ZPH
	Sleeve	PQ015Y053ZZH	PQ025Y053ZZH	PQ033Y053ZZH

### Absolute Maximum Ratings

(Ta=25°C)

Parameter	Symbol	Rating	Unit
Input voltage	V <sub>IN</sub>	7	V
*1 Dropout voltage	V <sub>I-O</sub>	4	V
*1 ON/OFF control terminal voltage	V <sub>C</sub>	7	V
Output current	PQxxxY3H3ZxH Series	3.5	A
	PQxxxY053ZxH Series	5	
*2 Power dissipation	P <sub>D</sub>	35	W
*3 Junction temperature	T <sub>j</sub>	150	°C
Operating temperature	T <sub>opr</sub>	-20 to +80	°C
Storage temperature	T <sub>stg</sub>	-40 to +150	°C
Soldering temperature	T <sub>sol</sub>	260(10s)	°C

\*1 All are open except GND and applicable terminals.

\*2 PD: With infinite heat sink

\*3 Overheat protection may operate at T<sub>j</sub>:125°C to 150°C

### Outline Dimensions

(Unit : mm)

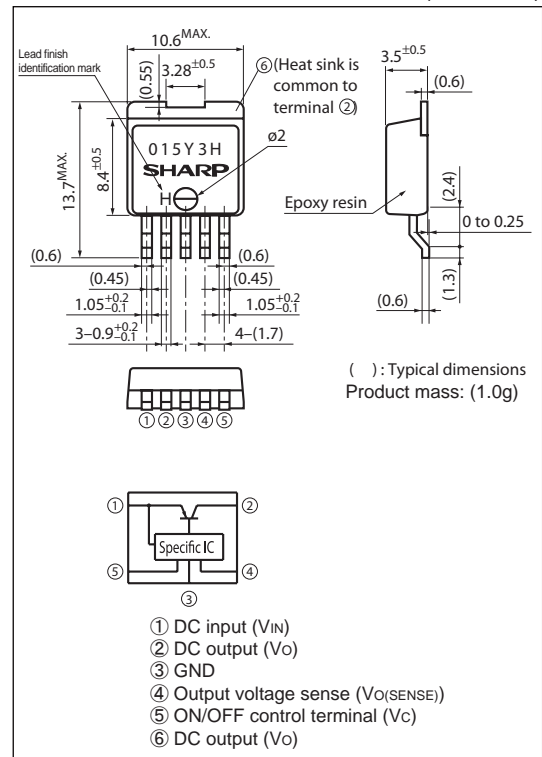

Notice The content of data sheet is subject to change without prior notice.

In the absence of confirmation by device specification sheets, SHARP takes no responsibility for any defects that may occur in equipment using any SHARP devices shown in catalogs, data books, etc. Contact SHARP in order to obtain the latest device specification sheets before using any SHARP device.

### Electrical Characteristics(PQ015Y3H3ZxH / PQ015Y053ZxH)

(Unless otherwise specified, condition shall be  $V_{IN}=5V$ ,  $I_o=1.75A$ (PQ015Y3H3ZxH),  $I_o=2.5A$ (PQ015Y053ZxH), connects  $V_{O(sense)}$  terminal to  $V_o$  terminal,  $T_a=25^\circ C$ )

Parameter	Symbol	Conditions	MIN.	TYP.	MAX.	Unit		
Input voltage	$V_{IN}$	-	2.35	-	7	V		
*4 Output voltage	$V_o$	Connects $V_{O(sense)}$ terminal to $V_o$ terminal	1.485	1.5	1.515	V		
Load regulation	PQ015Y3H3ZxH PQ015Y053ZxH	RegL	I <sub>o</sub> =5mA to 3.5A		-	0.1	0.5	%
			I <sub>o</sub> =5mA to 5A					
Line regulation	RegL	$V_{IN}=2.5$ to $5.5V$ , $I_o=5mA$	-	0.05	0.1	%		
Temperature coefficient of output voltage	$T_C V_o$	$T_j=0$ to $125^\circ C$ , $I_o=5mA$	-	$\pm 1$	-	%		
Ripple rejection	RR	Refer to Fig.2	60	70	-	dB		
*5 ON-state voltage for control	$V_{C(ON)}$	-	2.0	-	-	V		
ON-state current for control	$I_{C(ON)}$	$V_c=2.7V$	-	-	20	$\mu A$		
OFF-state voltage for control	$V_{C(OFF)}$	-	-	-	0.8	V		
OFF-state current for control	$I_{C(OFF)}$	$V_c=0.4V$	-	-	-0.4	mA		
Quiescent current	$I_q$	$I_o=0A$	-	5	10	mA		

### Electrical Characteristics(PQ025Y3H3ZxH / PQ025Y053ZxH)

(Unless otherwise specified, condition shall be  $V_{IN}=5V$ ,  $I_o=1.75A$ (PQ025Y3H3ZxH),  $I_o=2.5A$ (PQ025Y053ZxH), connects  $V_{O(sense)}$  terminal to  $V_o$  terminal,  $T_a=25^\circ C$ )

Parameter	Symbol	Conditions	MIN.	TYP.	MAX.	Unit		
*4 Output voltage	$V_o$	Connects $V_{O(sense)}$ terminal to $V_o$ terminal	2.475	2.5	2.525	V		
Load regulation	PQ025Y3H3ZxH PQ025Y053ZxH	RegL	I <sub>o</sub> =5mA to 3.5A		-	0.1	0.5	%
			I <sub>o</sub> =5mA to 5A					
Line regulation	RegL	$V_{IN}=3$ to $6.5V$ , $I_o=5mA$	-	0.05	0.1	%		
Temperature coefficient of output voltage	$T_C V_o$	$T_j=0$ to $125^\circ C$ , $I_o=5mA$	-	$\pm 1$	-	%		
Ripple rejection	RR	Refer to Fig.2	60	70	-	dB		
Dropout voltage	PQ025Y3H3ZxH PQ025Y053ZxH	$V_{I-O}$	*6 I <sub>o</sub> =3.5A		-	-	0.5	V
			*6 I <sub>o</sub> =5A					
*5 ON-state voltage for control	$V_{C(ON)}$	-	2.0	-	-	V		
ON-state current for control	$I_{C(ON)}$	$V_c=2.7V$	-	-	20	$\mu A$		
OFF-state voltage for control	$V_{C(OFF)}$	-	-	-	0.8	V		
OFF-state current for control	$I_{C(OFF)}$	$V_c=0.4V$	-	-	-0.4	mA		
Quiescent current	$I_q$	$I_o=0A$	-	5	10	mA		

### Electrical Characteristics(PQ033Y3H3ZxH / PQ033Y053ZxH)

(Unless otherwise specified, condition shall be  $V_{IN}=V_o(TYP)+1$ ,  $I_o=1.75A$ (PQ033Y3H3ZxH),  $I_o=2.5A$ (PQ033Y053ZxH), connects  $V_{O(sense)}$  terminal to  $V_o$  terminal,  $T_a=25^\circ C$ )

Parameter	Symbol	Conditions	MIN.	TYP.	MAX.	Unit		
*4 Output voltage	$V_o$	Connects $V_{O(sense)}$ terminal to $V_o$ terminal	3.267	3.3	3.333	V		
Load regulation	PQ033Y3H3ZxH PQ033Y053ZxH	RegL	I <sub>o</sub> =5mA to 3.5A		-	0.1	0.5	%
			I <sub>o</sub> =5mA to 5A					
Line regulation	RegL	$V_{IN}=4$ to $7V$ , $I_o=5mA$	-	0.05	0.1	%		
Temperature coefficient of output voltage	$T_C V_o$	$T_j=0$ to $125^\circ C$ , $I_o=5mA$	-	$\pm 1$	-	%		
Ripple rejection	RR	Refer to Fig.2	60	70	-	dB		
Dropout voltage	PQ033Y3H3ZxH PQ033Y053ZxH	$V_{I-O}$	*6 I <sub>o</sub> =3.5A		-	-	0.5	V
			*6 I <sub>o</sub> =5A					
*5 ON-state voltage for control	$V_{C(ON)}$	-	2.0	-	-	V		
ON-state current for control	$I_{C(ON)}$	$V_c=2.7V$	-	-	20	$\mu A$		
OFF-state voltage for control	$V_{C(OFF)}$	-	-	-	0.8	V		
OFF-state current for control	$I_{C(OFF)}$	$V_c=0.4V$	-	-	-0.4	mA		
Quiescent current	$I_q$	$I_o=0A$	-	5	10	mA		

\* 4 Connects  $V_{O(sense)}$  terminal ④ to  $V_o$  terminal ②

\* 5 In case of opening control terminal ⑤, output voltage turns ON.

\* 6 Input voltage shall be the value when output voltage is 95% in comparison with the initial value.

Fig.1 Test Circuit

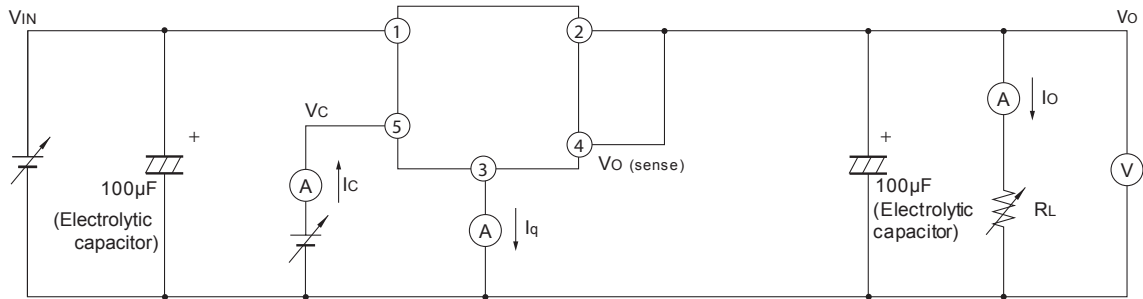

Fig.2 Test Circuit for Ripple Rejection

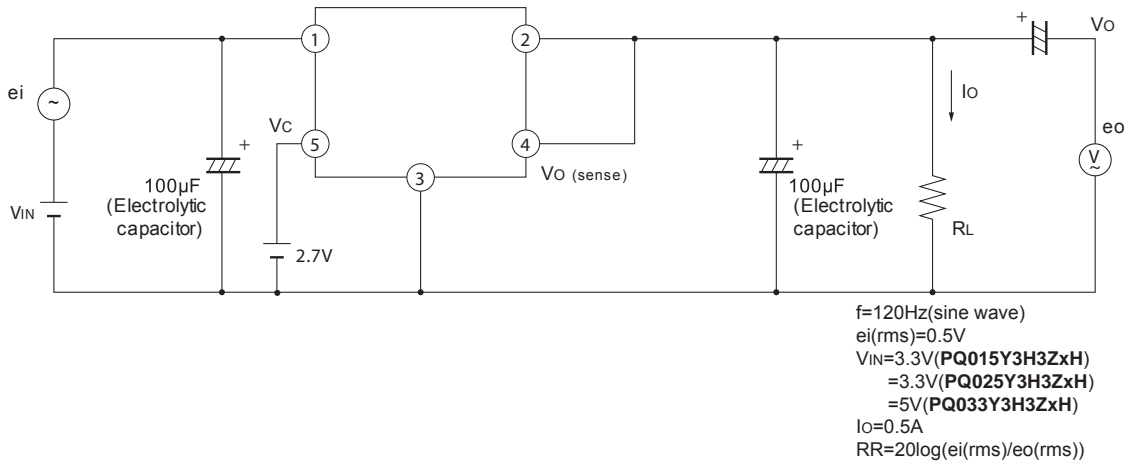
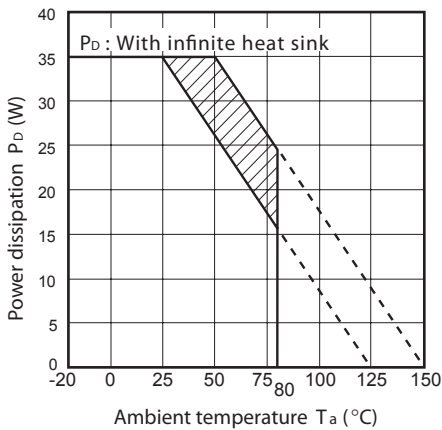

Fig.3 Power Dissipation vs. Ambient Temperature



Note) Oblique line portion: Overheat protection may operate in this area.

Fig.4 Overcurrent Protection Characteristics (PQ015Y3H3ZxH / PQ025Y3H3ZxH / PQ033Y3H3ZxH)

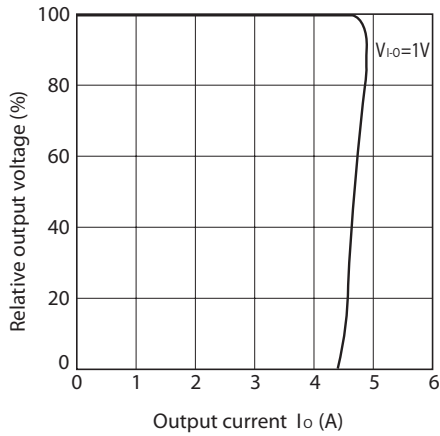

Fig.5 Overcurrent Protection Characteristics (PQ015Y053ZxH / PQ025Y053ZxH / PQ033Y053ZxH)

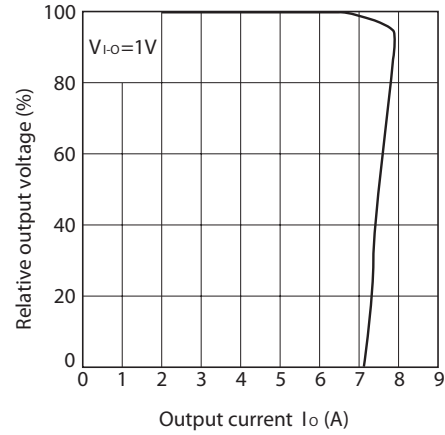

Fig.6 Output Voltage Fluctuation vs. Ambient Temperature

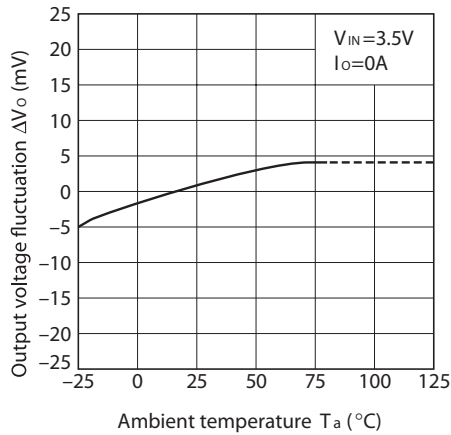

Fig.7 Output Voltage vs. Input Voltage (PQ015Y3H3ZxH)

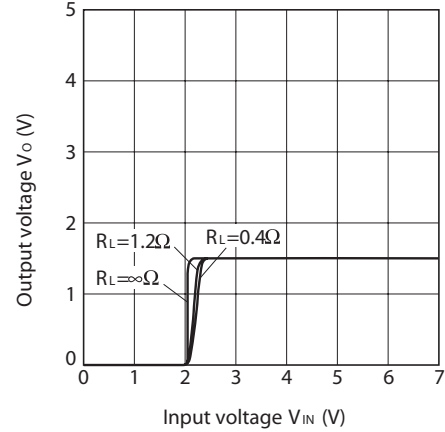

Fig.8 Output Voltage vs. Input Voltage (PQ015Y053ZxH)

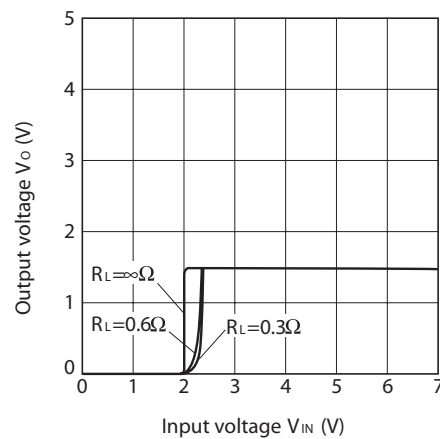

Fig.9 Output Voltage vs. Input Voltage (PQ025Y3H3ZxH)

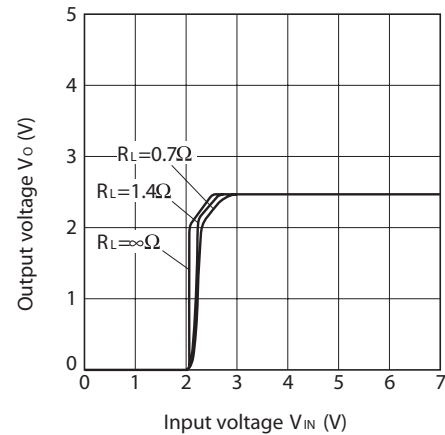

Fig.10 Output Voltage vs. Input Voltage (PQ025Y053ZxH)

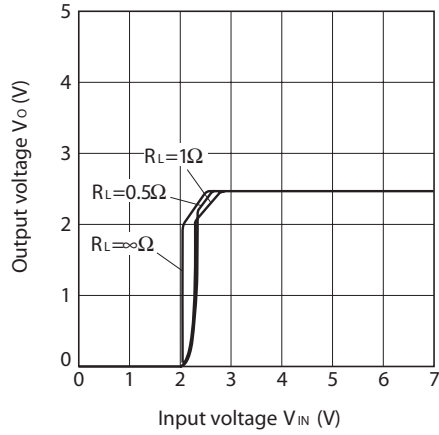

Fig.11 Output Voltage vs. Input Voltage (PQ033Y3H3ZxH)

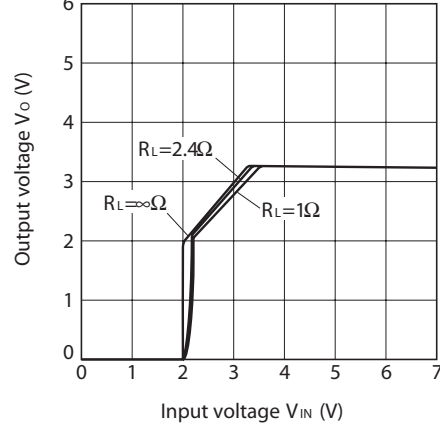

Fig.12 Circuit Operating Current vs. Input Voltage (PQ015Y3H3ZxH)

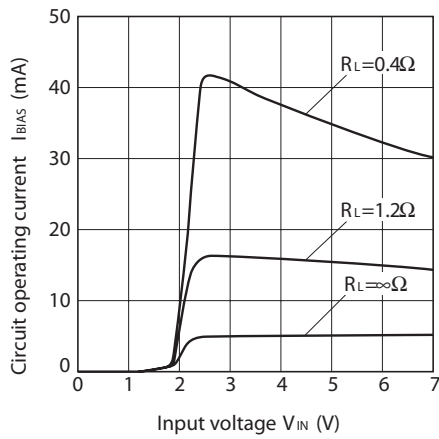

Fig.13 Circuit Operating Current vs. Input Voltage (PQ015Y053ZxH)

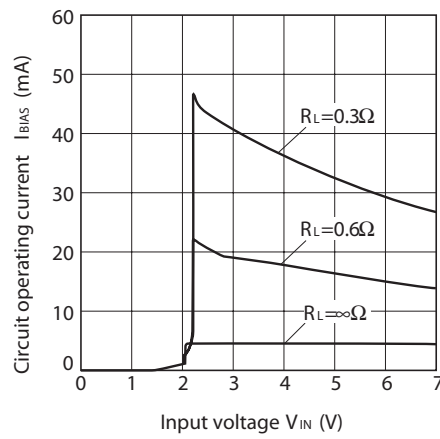

Fig.14 Circuit Operating Current vs. Input Voltage (PQ025Y3H3ZxH)

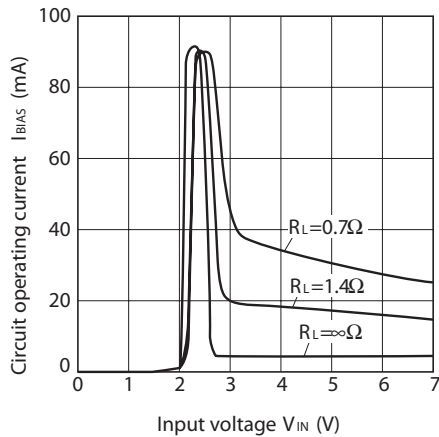

Fig.15 Circuit Operating Current vs. Input Voltage (PQ025Y053ZxH)

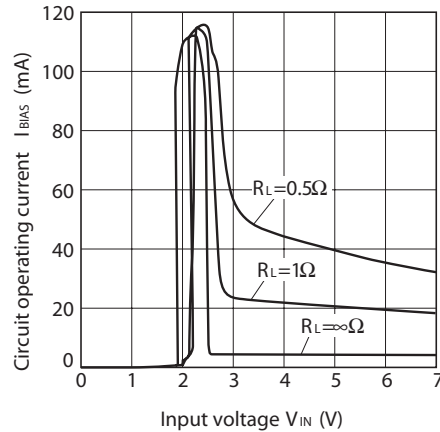

Fig.16 Circuit Operating Current vs. Input Voltage (PQ033Y3H3ZxH)

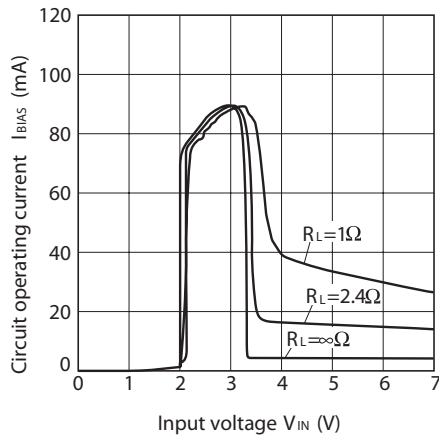

Fig.17 Ripple Rejection vs. Input Ripple Frequency (PQ025Y3H3ZxH)

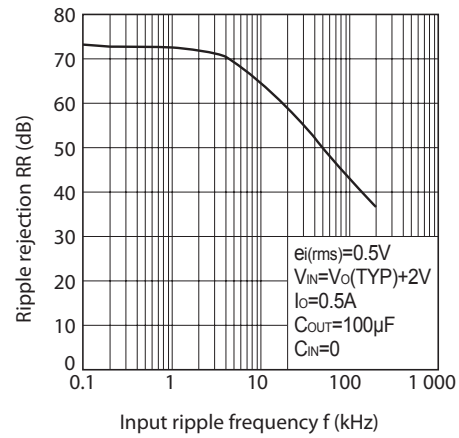
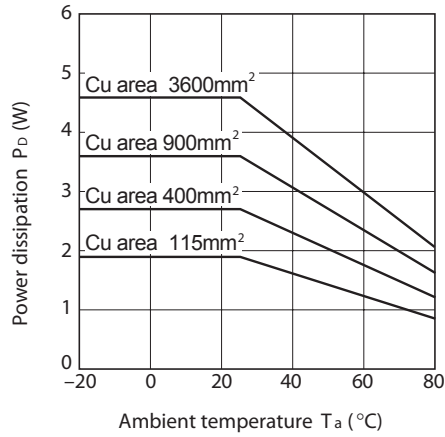
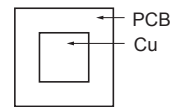

Fig.18 Power Dissipation vs. Ambient Temperature (Typical Value)



Mounting PCB



Material : Glass-cloth epoxy resin  
 Size : 60×60×1.6mm  
 Cu thickness : 65μm

Fig.19 Typical Application

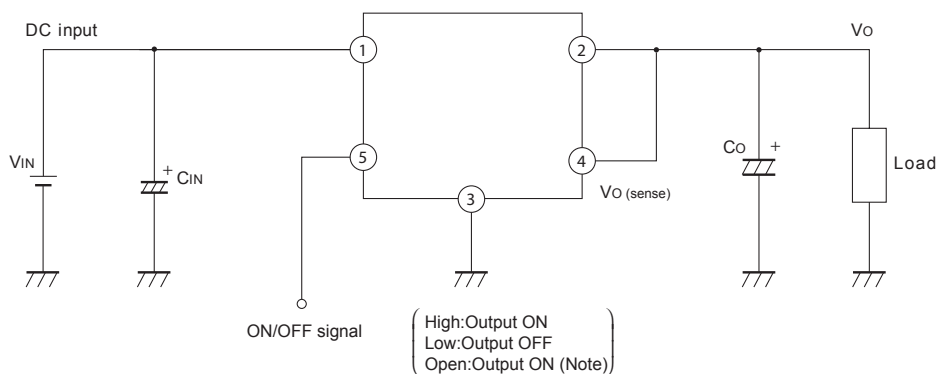

Please make sure to use this device, pulling up to the power supply with less than 7V at the resistor less than 50kΩ in switching ON/OFF with open collector output or in not using ON/OFF function (in keeping "ON"), because input impedance is high in ON/OFF terminals.